

MODULATOR INTERFACING

I/Q INPUTS

The AM3570A is designed for easy interfacing to both single-ended and differential I and Q sources. The modulator's I and Q inputs are differential with 100 Ω input impedance. The I/Q common-mode voltage range (DC bias) is -2.5 V to +2.5 V. The differential-mode voltage range is -1 V to +1 V. Internal lowpass filters set the modulator's I/Q baseband 3 dB bandwidth to 300 MHz. Contact the factory for other available filter bandwidths.

SINGLE-ENDED I/Q DRIVE

The AM3570A can be driven with single-ended I/Q signals. Connect the single-ended I and Q sources directly to the modulator's I and Q inputs as shown in Figure 1. To minimize LO leakage, terminate the unused \bar{I} and \bar{Q} inputs with matched DC resistances to ground. The termination resistance should be chosen to provide the modulator's 4 I/Q input ports with identical resistance to ground at DC (0 Hz).

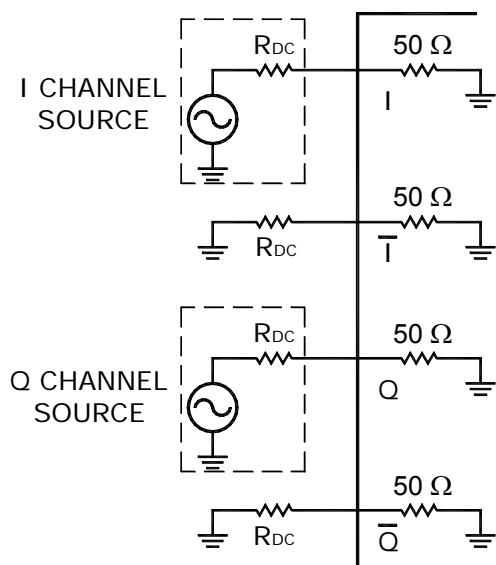

Figure 1. Single-Ended I/Q Drive

For example, if the I and Q input signals are provided by an arbitrary waveform generator having 50 Ω source impedance, the unused \bar{I} and \bar{Q} inputs should each be terminated with 50 Ω resistances to ground. If the I and Q input signals are AC-coupled then the \bar{I} and \bar{Q} inputs should be left open.

DAC INTERFACING

The AM3570A is designed for direct connection to high-speed DACs having differential current-source outputs. One example is the Analog Devices AD9783, a dual 16-bit 500 MSPS DAC. Figure 2 shows the AD9783 DAC driving the AM3570A modulator. No external resistors, amplifiers, or filters are required.

When configured for 20 mA full-scale current, the AD9783 provides the AM3570A with 1 V_{p-p} differential signals centered at a common-mode voltage of 500 mV.

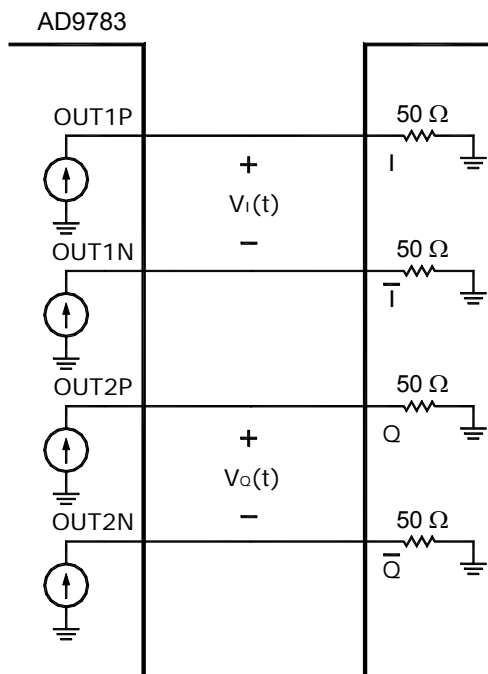

Figure 2. AD9783 Driving AM3570A